

ICOM

INSTRUCTION MANUAL

VHF MARINE TRANSCEIVER
(U.K. version)

IC-M15E

Icom Inc.

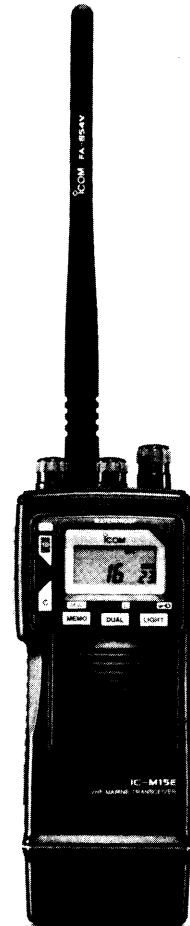

IMPORTANT

READ ALL INSTRUCTIONS carefully and completely before using the transceiver.

SAVE THIS INSTRUCTION MANUAL – This instruction manual contains important safety and operating instructions for the IC-M15E.

UNPACKING

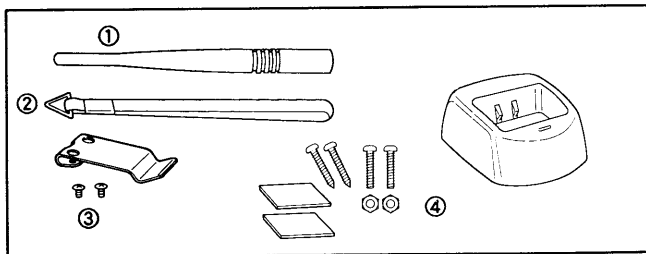

Accessories included with the IC-M15E:	Qty.
① Flexible antenna (FA-S54V)	1
② Handstrap	1
③ Belt clip and screws	1 set
④ Battery charge adapter (AD-43), screws and inserts	1 set

The CM-138 Ni-Cd battery pack comes attached to the transceiver.

CAUTIONS

MAKE SURE the battery pack is securely attached to the transceiver and that the battery pack is dry before attachment. Exposing the inside of the transceiver to water will result in serious damage to the transceiver.

KEEP the transceiver out of the reach of children.

KEEP the transceiver at least 1 m away from the ship's compass.

NEVER charge battery packs except in the methods described in this manual.

AVOID exposing the transceiver to direct sunlight for long periods of time.

AVOID using the transceiver in areas with temperatures below -20°C or above $+60^{\circ}\text{C}$.

BE CAREFUL! The IC-M15E is water-proof to a depth of 1 m only. At depths greater than 1 m, damage may result.

After exposure to saltwater, clean the transceiver thoroughly with fresh water to avoid corrosion.

TABLE OF CONTENTS

IMPORTANT	i	4 MEMORY CHANNEL PROGRAMMING	11
UNPACKING	i	5 SET MODE.....	12
CAUTIONS	i	■ Set mode programming	12
TABLE OF CONTENTS	ii	■ Set mode items	12
1 PRE-OPERATION	1-4	6 SCAN FUNCTIONS	13-14
■ Operating rules	1	■ Scan types	13
■ Accessory attachment	2	■ Starting a scan	14
■ Cautions	3	■ Channel lockout	14
■ Charging notes	3	7 OPTIONAL VOICE SCRAMBLER UNIT	15-16
■ Battery life	3	■ Installation	15
■ Battery pack removal	3	■ Activating the scrambler	16
■ Battery charging	4	■ Programming codes	16
2 PANEL DESCRIPTION	5-7	8 TROUBLESHOOTING	17
■ Front and side panels	5	■ Troubleshooting	17
■ Top panel	6	9 CHANNEL LIST	18
■ Function display	7	10 SPECIFICATIONS AND OPTIONS	19-20
3 BASIC OPERATION	8-10	■ Specifications	19
■ Channel selection	8	■ Options	20
■ Receiving	9		
■ Dual watch/tri-watch	9		
■ Transmitting	10		
■ Lock function	10		
■ Function display backlighting	10		

■ Operating rules

• PRIORITIES

- 1) Read all rules and regulations pertaining to priorities and keep an up-to-date copy handy. Safety and distress calls take priority over all others.
- 2) You must monitor channel 16 when you are not operating on another channel.
- 3) False or fraudulent distress calls are prohibited under law.

• PRIVACY

- 1) Information overheard but not intended for you cannot lawfully be used in any way.
- 2) Indecent or profane language is prohibited.

• RADIO LICENSES

(1) SHIP STATION LICENSE

When your craft is equipped with a VHF FM transceiver, you must have a current radio station license before using the transceiver. It is unlawful to operate a ship station which is not licensed.

Inquire through your dealer or the appropriate government agency for a Ship-Radiotelephone license. This license includes the call sign which is your craft's identification for radio purposes.

(2) OPERATOR'S LICENSE

A Restricted Radiotelephone Operator Permit is the license most often held by small vessel radio operators when a radio is not required for safety purposes. You can usually obtain this permit by mail.

The Restricted Radiotelephone Operator Permit must be posted near the transceiver or be kept with the operator. Only a licensed radio operator may operate a transceiver.

However, non-licensed individuals may talk over a transceiver if a licensed operator starts, supervises, ends the call and makes the necessary log entries.

A current copy of the applicable government rules and regulations is usually required to be on hand.

■ Accessory attachment

◇ FLEXIBLE ANTENNA

Insert the base of the flexible antenna into the antenna connector; then rotate the flexible antenna in a clockwise direction until it is securely fastened to the transceiver.

/// **CAUTION:** Transmitting without an antenna may damage the transceiver.

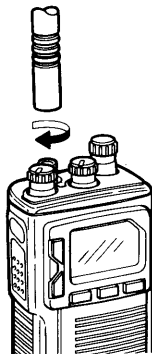

◇ BELT CLIP

Attach the belt clip using the supplied metal screws. Conveniently attaches to your belt.

/// **CAUTION:** NEVER use screws other than the supplied ones.

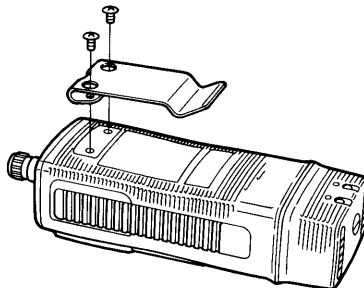

◇ HANDSTRAP

Attach the handstrap to the belt clip as indicated in the diagram below. Facilitates carrying.

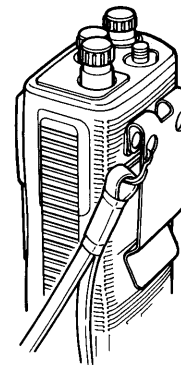

1 PRE-OPERATION

■ Cautions

NEVER incinerate used battery packs. Internal battery gas may cause an explosion.

NEVER immerse the battery pack in water. If the battery pack becomes wet, be sure to wipe it dry **BEFORE** attaching it to the transceiver.

NEVER short terminals of the battery pack. Internal components may become damaged. Also, current may flow into nearby metal objects so be careful when placing battery packs in handbags, etc.

■ Charging notes

- The transceiver must be turned OFF when charging a battery pack attached to the transceiver. Failure to do so may damage the transceiver.
- Charging may not be successful in extreme cold (under 10°C ; +50°F) or extreme heat (over +40°C ; +104°F).
- The use of non-Icom battery packschargers may impair transceiver performance and invalidate the warranty.

■ Battery life

If your battery pack seems to have no capacity even after being charged, completely discharge it by leaving the power ON overnight. Then, fully charge the battery pack again. If the battery pack still does not retain a charge (or very little), a new battery pack must be purchased.

■ Battery pack removal

The IC-M15E's water-proof construction is only maintained when the battery pack is securely attached to the transceiver body. We recommend battery pack removal only when absolutely necessary i.e. when exchanging the attached battery pack for another one.

To remove: use a coin or flat-head screwdriver to loosen the bottom screw, then slide the battery pack free of the transceiver.

To attach: reverse the above process.

CAUTION: To ensure water-tightness, the bottom screw must be securely attached to the transceiver.

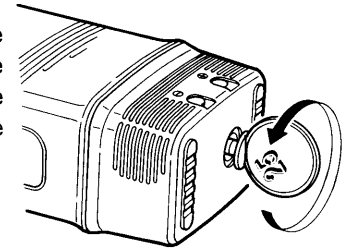

■ Battery charging

• Using the supplied charge adapter

Insert the transceiver and attached battery pack into the charging slot of the AD-43.

Connect an AC adapter or an optional CM-1 CIGARETTE LIGHTER CABLE (12 V socket only) here.

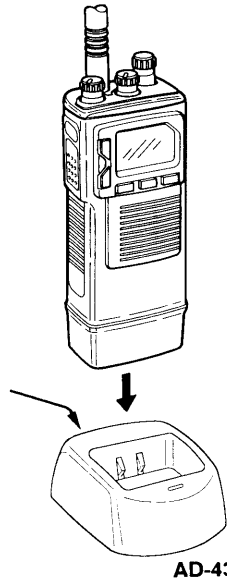

AD-43

◇ When charging in unstable places such as aboard a ship, use the supplied self-tapping screws, or nuts and bolts, plus the inserts to stabilize the AD-43 to a solid, flat surface and prevent the transceiver from popping out of the AD-43.

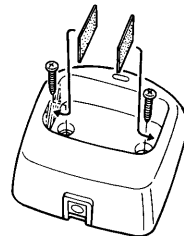

Charging time: 15 to 20 hrs. (approx.)

• Using an optional BM-103

Insert the transceiver and attached battery pack or a battery pack only into the charging slot of the BM-103.

Connect an AC adapter or an optional CM-1 CIGARETTE LIGHTER CABLE (12 V socket only) here.

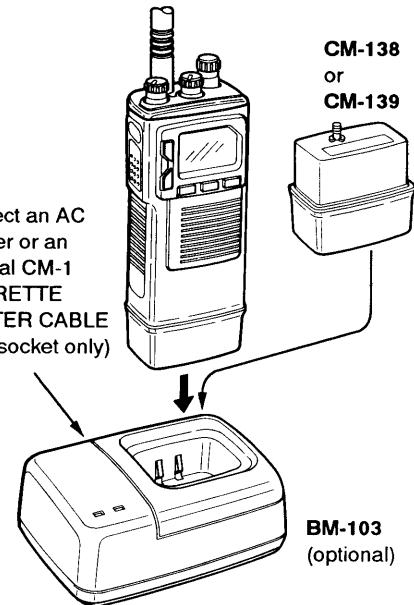
BM-103
(optional)

Charging time: 1 to 2 hrs. (approx.)

2

PANEL DESCRIPTION

■ Front and side panels

TRANSMIT POWER SWITCH

[HI/LOW] (p. 10)

Selects high or low output power. Also activates the secondary function of other switches.

PTT SWITCH [PTT] (p. 10)

Push and hold to transmit; release to receive.

CHANNEL 16 SWITCH [16•I/U]

(p. 8)

Toggles between channel 16 and a regular channel. When [HI/LOW] is pushed and held on a regular channel, toggles between INT and USA channels.

CALL SWITCH [C] (p. 8)

Toggles between the call channel and a regular channel.

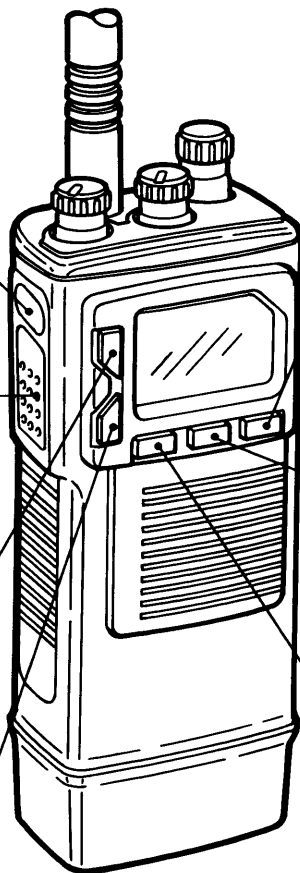

LIGHT SWITCH

[LIGHT•SCRM] (pgs. 10, 16)

Turns the function display lighting ON and OFF. When pushed and held, activates the optional scrambler unit. In addition, when [HI/LOW] is pushed and held, activates the lock function.

DUAL WATCH SWITCH

[DUAL•SCAN] (pgs. 9, 14)

Starts and stops dual/tri-watch. When pushed and held, starts one of the scans. In addition, when [HI/LOW] is pushed and held, this switch locks out the indicated channel.

MEMO SWITCH [MEMO/MW]

(p. 8)

Selects a memory channel. When [HI/LOW] is pushed, writes the indicated channel into a selected memory.

■ Top panel

ANTENNA CONNECTOR (p. 2)

Connects the supplied flexible antenna.

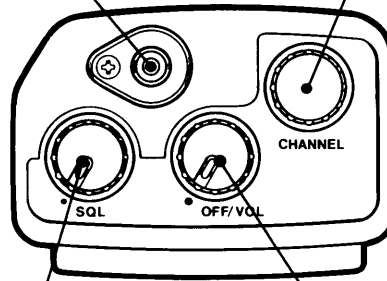

CHANNEL SELECTOR [CHANNEL] (p. 9)

Sets an international channel or USA channel during normal operation, depending on which channel group is selected.

Sets a memory channel while in memory mode.

Also used to select a scramble code when the optional voice scrambler unit is installed.

SQUELCH CONTROL [SQL] (p. 9)

Sets the squelch threshold point for audio mute.

VOLUME CONTROL [VOL] (p. 9)

Turns power ON and adjusts the audio level.

2 PANEL DESCRIPTION

■ Function display

BUSY INDICATOR (p. 9)

Appears when receiving a signal or when [SQL] is rotated too far counterclockwise.

TRANSMIT INDICATOR (p. 10)

Appears while transmitting.

LOCK INDICATOR (p. 10)

Appears while the lock function is activated.

DUAL WATCH INDICATOR (p. 9)

"DUAL" appears during dual watch; "DUAL" and "▼" appear during tri-watch.

CALL CHANNEL INDICATOR (p. 8)

Indicates the call channel is selected.

TRANSMIT POWER INDICATOR (p. 10)

Appears when low output power is selected; disappears when high output power is selected.

High output power cannot be selected on some channels. (See channel list, p. 18.)

SCAN INDICATOR (p. 14)

Appears while a scan is activated.

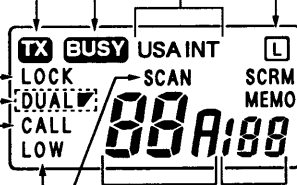

CHANNEL INDICATORS (p. 8)

Indicate whether an international or USA channel is displayed.

LOCKOUT CHANNEL INDICATOR (p. 14)

Appears when the displayed channel is locked out.

SCRAMBLER INDICATOR (p. 16)

Appears when the optional voice scrambler function is activated.

MEMORY INDICATOR (p. 8)

Appears when in memory mode.

MEMORY CHANNEL/SCRAMBLE NUMBER CODE (pgs.11, 16)

Indicates the selected memory channel number or the scrambler code number while setting a scramble code. In SET mode, indicates the selected condition.

CHANNEL NUMBER INDICATOR (p. 8)

Indicates the selected operating channel number. In SET mode, indicates the selected item.

Channel selection

◇ Channel 16

Channel 16 is the distress channel. It is used for establishing initial contact with another station and for emergency communications. While standing by you are required to monitor channel 16.



◇ Regular channels

There are 57 INT and 58 USA channels. Establish initial contact on channel 16, then move to an agreed upon channel for communications.

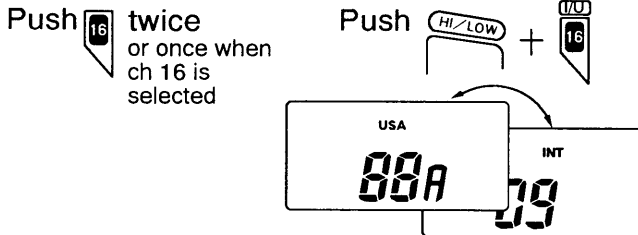

- Pushing [C] or [MEMO] twice also selects a regular channel.
- Rotate the channel selector to set the desired channel.

◇ Call channel

The call channel is used to store channel 37A for quick recall. In addition, the call channel is monitored during tri-watch.

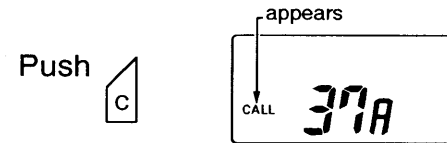

◇ Memory channels

24 memory channels are used to store often-used frequencies for easy recall and scanning. After shipping from the factory or after resetting the CPU (p. 17) only memory channel 00 is programmed.

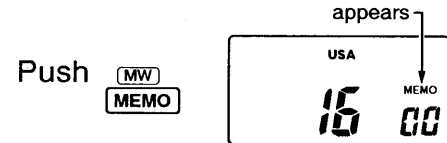

- Rotate the channel selector to set the desired memory channel.
- See p. 11 for memory channel programming.

3 BASIC OPERATION

■ Receiving

- 1) Rotate [VOL] clockwise to turn power ON.
- 2) Rotate [SQL] fully counterclockwise.
- 3) Adjust the audio to a suitable level using [VOL].
- 4) Rotate [SQL] clockwise until audio noise is just muted.
- 5) Rotate [CHANNEL] to set the desired channel for receiving.
 - When receiving a signal, **BUSY** appears and audio is emitted from the speaker.

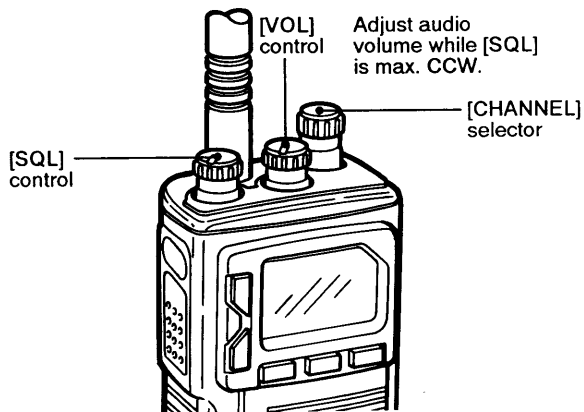

■ Dual watch/tri-watch

This function monitors channel 16 (and the call channel in the case of tri-watch) while waiting on a selected channel. Set the transceiver for tri- or dual watch in SET mode depending on your preference. (See p. 12.)

- 1) Set your desired receive channel. See p. 8.
 - If the call channel is selected, only dual watch is possible.
- 2) Push [DUAL] to activate the watch.
 - When a signal is received on Ch 16 the watch pauses until the signal disappears.
 - When a signal pauses on the call channel, Ch 16 is still monitored.
- 3) Push [DUAL] to cancel the watch.

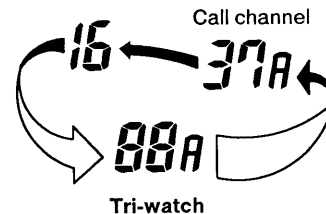
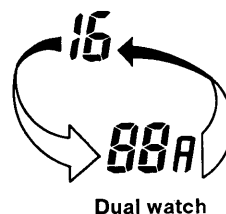
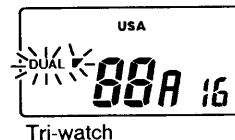
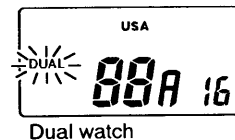

■ Transmitting

CAUTION: Transmitting without an antenna may damage the transceiver.

Set the transceiver as for receiving, then:

- 1) Set the desired channel using [CHANNEL].
- 2) Push [HI/LOW] to select the output power.
 - "LOW" appears when low power is selected.
 - Choose low power to conserve battery power; choose high power for longer distance communications.
- 3) Push and hold [PTT] to transmit.
 -  appears.
 - Some channels are for low power output only. (See channel list, p. 18).
 - To ensure privacy, use the voice scrambler function when transmitting. An optional UT-79 must be installed.
- 4) Speak into the microphone.
 - DO NOT hold the transceiver too closely to your mouth or speak too loudly. This may distort the signal.
- 5) Release [PTT] to receive.

■ Lock function

This function electronically locks all keys and switches to prevent accidental frequency changes and function access.

- 1) While pushing [HI/LOW], push [LIGHT•SCRM ].
 - Only [PTT], [HI/LOW] and [LIGHT] are functional.

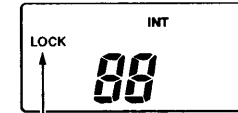

appears

- 2) To cancel the function, repeat step 1 above.
 - "LOCK" disappears from the function display.

■ Function display backlighting

This is convenient for nighttime operation.

- 1) Push [LIGHT] to turn the function display backlighting ON.
 - The backlighting automatically turns OFF after 5 sec. if no other keys or switches are pushed during that time.
 - To conserve battery power, use the backlighting only when necessary.
- 2) To turn the function display backlighting OFF before 5 sec. have elapsed, push [LIGHT] again.

4

MEMORY CHANNEL PROGRAMMING

◇ To program:

1) Push [MEMO] to select a memory channel.

2) While pushing [HI/LOW], push [MEMO•MW].

- "MEMO" and the memory channel number flash.

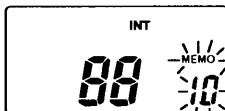

3) Rotate [CHANNEL] until the desired memory appears.

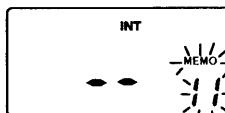

4) Push [MEMO] again.

- Channel number flashes.

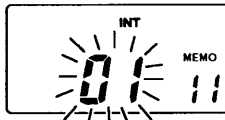

5) Rotate [CHANNEL] until the desired channel appears.

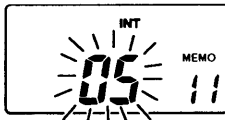

6) While pushing [HI/LOW], push [MEMO•MW] to complete programming.

- Channel number stops flashing.



SET mode programming

SET mode is used to change the conditions of 3 transceiver functions: the power saver function, the dual/tri-watch function and the scan function.

- 1) Turn power OFF.
- 2) While pushing [HI/LOW], turn power ON and continue pushing [HI/LOW] until the display appears.
- 3) After the display appears, release [HI/LOW].
- 4) Push [HI/LOW] to select the desired item, if necessary.
- 5) Rotate [CHANNEL] to select the desired condition of the item as shown in the table at right.
- 6) To exit SET mode, push [16].
 - Turning power OFF, then ON again also exits SET mode.

These displays show the default settings.

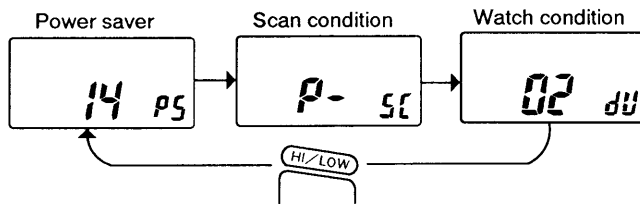

SET mode items

DISPLAY	CONDITION	COMMENT
00 p5	Power saver OFF	The power saver function helps conserve battery power by automatically resting the receiver circuit when the transceiver is idle. For maximum battery conservation, choose the highest duty cycle:
14 p5	Power saver duty cycle 1 : 4	
18 p5	Power saver duty cycle 1 : 8	
P- 5C	Priority scan	Select priority scan if you want to monitor the distress channel (16) while scanning.
L- 5C	Normal scan	
02 dU	Dual watch operation	Choose tri-watch if you want to monitor the call channel in addition to channel 16 and a selected channel.
03 dU	Tri-watch operation	

6

SCAN FUNCTIONS

Scan types

Scanning is an efficient way to locate signals quickly over a wide frequency range. The IC-M15E has 4 scan types:

Priority scans search through all channels/memory channels in sequence while monitoring channel 16. When a signal is detected on channel 16, scan pauses until the signal disappears; when a signal is detected on a channel other than channel 16, scan becomes dual watch until the signal disappears.

Normal scans, like priority scans, search through all channels/memory channels in sequence. However, unlike priority scan, channel 16 is only checked in sequence as other channels/memory channels are.

NOTE: Choose either priority or normal scan in SET mode (see p. 12).

- Priority regular scan
- Normal regular scan
- Priority memory scan
- Normal memory scan

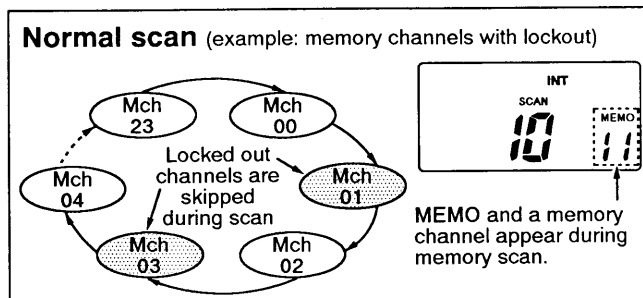
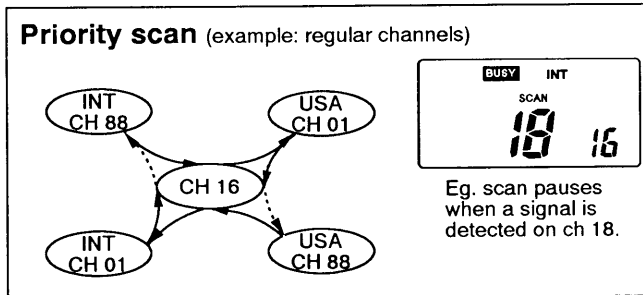



■ Starting a scan

Set priority scan or normal scan in advance using SET mode (see p. 12).

- 1) Make sure channel 16 or the call channel is not selected.
 - Select a regular channel or memory channel (see p. 8).
- 2) Push and hold [SCAN] for 2 seconds.
 - "SCAN" appears in the function display.
 - When a signal is detected, scan pauses until the signal disappears. (Ch 16 is still monitored during priority scan.)
- 3) To stop the scan, push [SCAN].
 - "SCAN" disappears.
 - Pushing [16], [C] or [MEMO] also stops the scan.

■ Channel lockout

For more efficient scanning, set unwanted channels as lockout channels. Channels set as lockout channels will be skipped during scanning. Channel lockout is assigned to regular channels and memory channels independently.

- 1) Select the channel to be locked out (either a regular channel or a memory channel).
 - Channel 16 or the call channel CANNOT be locked out.
- 2) While pushing [HI/LOW], push [DUAL•SCAN ].
 - "  " appears in the function display and the channel is locked out.
- 3) To unlock a channel, repeat step 2) above.

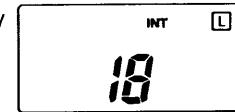

This example shows a regular channel locked out.

Starting a scan (example — priority scan of regular channels):

Select a regular channel if necessary.



Push for 2 secs. Scan starts

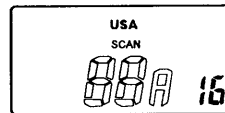

Scan pauses when receiving a signal and audio is emitted.



Dual watch begins.

Push to stop the scan.



Installation

Installing the optional UT-79 scrambler unit into the IC-M15E requires partial disassembly of the transceiver. Incorrect reassembly after removing the outer case may ruin its water-proof rating. Have your Icom Dealer install the scrambler unit for you as outlined below.

After removing the battery pack and flexible antenna:

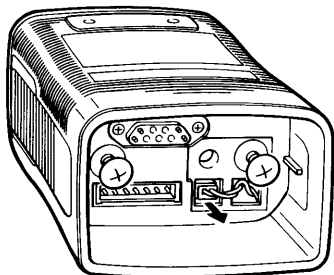

- ① Unplug the connector, loosen the 2 bottom screws; then remove the case.

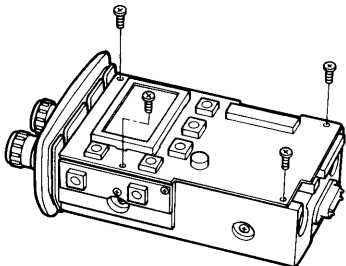

- ② Remove the 4 P. C. board screws.

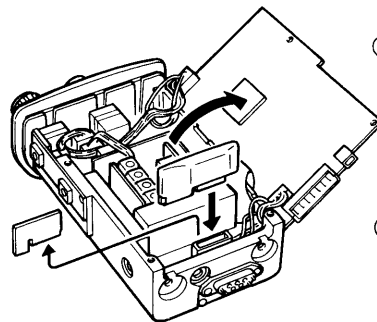

- ③ Open the P. C. board; then, remove the small unit and install the scrambler unit in its place.

- ④ Close the P. C. board; then, replace the 4 screws.

- ⑤ Before reattaching the case, apply silicone grease to the upper inside of the transceiver case.

- Recommended silicone grease:
Manufacturer – Shin-Etsu Chemical; type – G-501.

- ⑥ Reassemble the transceiver.

- Make sure the connector cables are tucked inside the opening for protection from the battery pack.

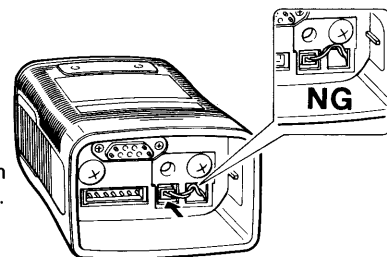

CAUTION: Make sure the 2 bottom screws are securely tightened to ensure that the transceiver remains water-tight and no water is able to seep inside the casing.

■ Activating the scrambler

The optional voice scrambler provides private communications. In order to receive or send scrambled transmissions you must first activate the scrambler function. To activate the function:

- 1) Push and hold [SCRM] for 2 seconds.
 - The transceiver emits 2 beeps and "SCRM" appears in the function display.
- 2) To turn the scrambler function OFF, repeat step 1).
 - The transceiver emits 2 beeps and "SCRM" disappears from the function display.



NOTE: The voice scrambler function CANNOT be activated on Channel 16.

■ Programming codes

There are 128 codes available for programming. In order to understand one another, all transceivers in your group must have the same code programmed into the channel you are communicating on.

- 1) Select the channel you wish to program a code into.
 - Channel 16 cannot be selected.
- 2) Make sure the scramble function is OFF, then push and hold [SCRM] until "SCRM" appears.
- 3) While continuing to push [SCRM], rotate the channel selector to select the desired scramble code.
- 4) Release [SCRM].
 - The scramble code disappears from the function display but remains in effect while the scramble function is activated.

[Example]: Programming scramble code 127.

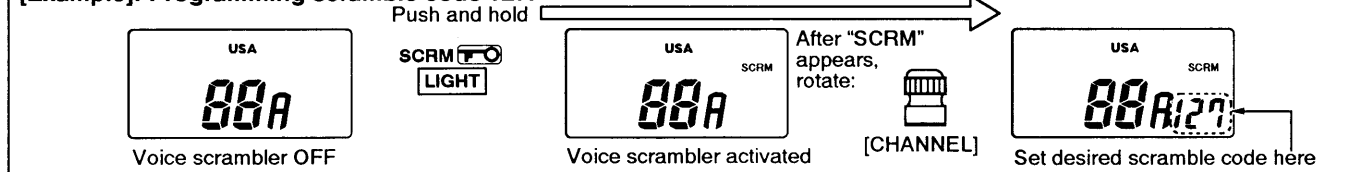

8

TROUBLESHOOTING

■ Troubleshooting

PROBLEM	POSSIBLE CAUSE	SOLUTION	REF.
No power comes ON.	<ul style="list-style-type: none"> The battery is exhausted. Bad connection to the battery pack. 	<ul style="list-style-type: none"> Recharge the battery pack. Check the connection to the transceiver. 	p. 3-4 p. 4
No sound comes from the speaker.	<ul style="list-style-type: none"> [SQL] is turned too far CW. [VOL] is turned completely CCW. 	<ul style="list-style-type: none"> Set [SQL] to the threshold point. Set [VOL] to a suitable level. 	p. 9 p. 9
Transmitting is impossible, or high power cannot be selected.	<ul style="list-style-type: none"> Ch 15, 17 and 70 are for low power only. The battery is exhausted. The output power is set to low. 	<ul style="list-style-type: none"> Change channels. Replace or charge the batteries. Push [HI/LOW] to select high output power. 	p. 10 p. 3-4 p. 10
The displayed channel cannot be changed.	<ul style="list-style-type: none"> Lock function is activated. Channel 16 mode has been selected. Dual/tri-watch has been activated. Scan has been activated. 	<ul style="list-style-type: none"> While pushing [HI/LOW], push [LIGHT ]. Push [16] to return to normal operation. Push [DUAL•SCAN] to cancel dual/tri-watch. Push and hold [DUAL•SCAN] to cancel scan. 	p. 10 p. 8 p. 9 p. 14
Scanning or dual watch/tri-watch does not function.	<ul style="list-style-type: none"> Channel 16 mode has been selected. The squelch is open. 	<ul style="list-style-type: none"> Push [16] to return to normal operation. Rotate [SQL] clockwise. 	p. 8 p. 14
Memory scan does not function	<ul style="list-style-type: none"> 2 or more memory channels must be programmed with channel information 	<ul style="list-style-type: none"> Program 2 or more memory channels with channel information 	p. 11
Dual watch functions but tri-watch doesn't or vice versa.	<ul style="list-style-type: none"> You must set the transceiver to operate one or the other. 	<ul style="list-style-type: none"> Select dual watch or tri-watch operation in SET mode. 	p. 12
Receive signal cannot be understood.	<ul style="list-style-type: none"> Optional voice scrambler is turned OFF. Voice scrambling code is not set correctly. 	<ul style="list-style-type: none"> Turn the optional voice scrambler ON. Reset the scrambling code. 	p. 16 p. 16

CHANNEL LIST

9

Channel number		Frequency (MHz)	
INT	USA	Transmit	Receive
01		156.050	160.650
	01A	156.050	156.050
02		156.100	160.700
	02A	156.100	156.100
03		156.150	160.750
	03A	156.150	156.150
04		156.200	160.800
	04A	156.200	156.200
05		156.250	160.850
	05A	156.250	156.250
06	06	156.300	156.300
07		156.350	160.950
	07A	156.350	156.350
08	08	156.400	156.400
09	09	156.450	156.450
10	10	156.500	156.500
11	11	156.550	156.550
12	12	156.600	156.600
13	13*	156.650	156.650
14	14	156.700	156.700
15*	15†	156.750	156.750
16	16	156.800	156.800
17*	17*	156.850	156.850
18		156.900	161.500
	18A	156.900	156.900

Channel number		Frequency (MHz)	
INT	USA	Transmit	Receive
19		156.950	161.550
	19A	156.950	156.950
20	20	157.000	161.600
	20A	157.000	157.000
21		157.050	161.650
	21A	157.050	157.050
22		157.100	161.700
	22A	157.100	157.100
23		157.150	161.750
	23A	157.150	157.150
24	24	157.200	161.800
25	25	157.250	161.850
26	26	157.300	161.900
27	27	157.350	161.950
28	28	157.400	162.000
60		158.025	160.625
	60A	158.025	158.025
61		158.075	160.675
	61A	158.075	158.075
62		158.125	160.725
	62A	158.125	158.125
63		158.175	160.775
	63A	158.175	158.175
64		158.225	160.825
	64A	158.225	158.225

Channel number		Frequency (MHz)	
INT	USA	Transmit	Receive
65		156.275	160.875
	65A	156.275	156.275
66		156.325	160.925
	66A	156.325	156.325
67	67*	156.375	156.375
68	68	156.425	156.425
69	69	156.475	156.475
70*	70*	156.525	158.525
71	71	156.575	158.575
72	72	156.625	158.625
73	73	156.675	158.675
74	74	156.725	158.725
75	75	Guard	Guard
76	76	Guard	Guard
77	77	158.875	158.875
78		158.925	161.525
	78A	158.925	158.925
79		158.975	161.575
	79A	158.975	158.975
80		157.025	161.625
	80A	157.025	157.025
81		157.075	161.675
	81A	157.075	157.075
82		157.125	161.725
	82A	157.125	157.125

Channel number		Frequency (MHz)	
INT	USA	Transmit	Receive
83		157.175	161.775
	83A	157.175	157.175
84	84	157.225	161.825
		157.225	157.225
85	85	157.275	161.875
		157.275	157.275
86	86	157.325	161.925
	86A	157.325	157.325
87	87	157.375	161.975
		157.375	157.375
88	88	157.425	162.025
	88A	157.425	157.425

*Low power only †Transmit is inhibited

10 SPECIFICATIONS AND OPTIONS

■ Specifications

• GENERAL

Frequency coverage (MHz)	: Transmit 156–157.5
	: Receive 156–162.025
Mode	: FM (16K0G3E)
Channel spacing	: 25 kHz
Current drain	: TX High 3.0 A max.
(w/supplied battery pack)	: TX Low 1.5 A max.
	: Max. audio 600 mA max.
	: Power saved 15 mA typical (squelled)
Power supply requirement	: CM-138 or CM-139
Frequency stability	: 0.0005% (–20°C to +60°C)
Usable temperature range	: –20°C to +60°C
	: (–4 °F to +140°F)
Dimensions (with CM-138)	: 62(W) × 150(H) × 44(D) mm
	: 2.4(W) × 5.9(H) × 1.7(D) in
Weight (with CM-138)	: 460 g (16.2 oz)
Antenna impedance	: 50 Ω (unbalanced)

• TRANSMITTER

Output power	: High 5 W
	: Low 0.7 W
Modulation system	: Variable reactance phase modulation
Max. frequency deviation	: ± 5.0 kHz

• RECEIVER

Receive system	: Double-conversion superheterodyne
Sensitivity (12 dB SINAD)	: 0.35 μV
Squelch sensitivity	: Less than 0.3 μV (at threshold)
Audio output power	: 500 mW with an 8Ω load

All stated specifications are subject to change without notice or obligation.

Options

Icom offers a wide variety of options to suit your operating needs.

◇ CHARGERS

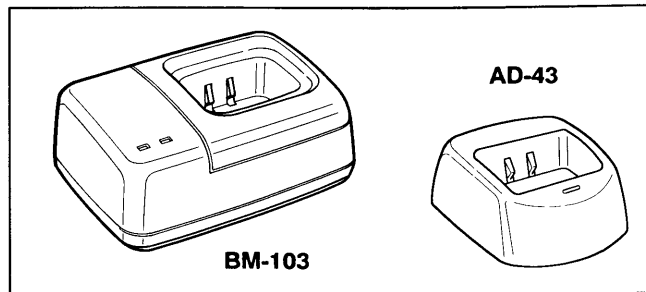

- **AD-43 BATTERY CHARGE ADAPTER**

Used for regular charging of battery packs. The same as the supplied one. Charging time: 15 to 20 hrs.

- **BM-103 DESKTOP CHARGER**

Used for rapid charging of battery packs.
Charging time: 1 to 3 hrs.

- **CM-1 CIGARETTE LIGHTER CABLE**

Connects to a ship's or vehicle's cigarette lighter socket for use with the BM-103 or AD-43.

◇ BATTERY PACKS

BATTERY PACK	OUTPUT VOLTAGE	CAPACITY	HEIGHT
CM-138	7.2 V	900 mAh	59 mm/2.3 in
CM-139	7.2 V	1200 mAh	72 mm/2.8 in

◇ OTHERS

- **FA-S54V FLEXIBLE ANTENNA**

Same type as supplied with the transceiver. Has an SMC type connector.

- **MB-24 MOUNTING BRACKET**

Hanger-type for mounting the transceiver in a vehicle.

- **MB-25 MOUNTING BRACKET**

Wall-type for mounting on a wall.

- **UT-79 VOICE SCRAMBLER UNIT**

Ensures private communications. 128 codes available.

Count on us!

A-5283H-1UK 
Printed in Japan
Copyright © 1994 by Icom Inc.



Icom Inc.

6-9-16, Kamihigashi, Hirano-ku, Osaka 547, Japan